



eArche™ PV System

Installation Manual

Contents

Purpose of this guide

Features & Benefits

Notices

General safety

Handling safety

Installation safety

Fire safety

Production Identification

Mechanical Installation

Grounding

Electrical installation

Disclaimer of liability

Products Data

Purpose of this guide

- This guide contains information regarding the installation and safe handling of Sunman (Zhenjiang) Company Limited eArche PV system. Sunman (Zhenjiang) Company Limited referred to as “SUNMAN”.
- Installers must read and understand this guide prior to installation. For any questions, please contact SUNMAN’s Customer Service Department “or our local representatives” for more detailed information. Installers should follow all safety precautions described in this guide as well as local codes when installing a eArche.
- Before installing a solar photovoltaic system, installers should familiarize themselves with its mechanical and electrical requirements. Keep this guide in a safe place for future reference (care and maintenance) and in case of sale or disposal of eArche.
- SUNMAN’s eArche are tested and certified for installations worldwide. Different regions may have different regulations for solar PV installations.

Features & Benefits

- Flexible layouts
- eArche™ PV system can be installed at any shape roofs, which has integrated appearance with buildings.
- Maximization installation quantity of eArche at any kinds roof.
- Quick installation
- Ultra-thin and light to save inatallation labor by a large margin.



Notices

This manual contains important installation instructions for the core hardware components required for eArche™ PV System PV arrays.

Copyright and Trademark Information

Copyright © 2019 by Sunman (Zhenjiang) Company Limited. All rights reserved.

eArche and the SUNMAN logo are trademarks of Sunman (Zhenjiang) Company Limited.

Warranty Warnings

“WARRANTY VOID IF NON-SUNMAN-CERTIFIED HARDWARE IS ATTACHED TO eArche™ PV System.”

For Further Information

For additional technical support documentation, please visit the Support page of the SUNMAN web site at www.sunman-energy.com

General safety

- eArche that fall under this application class may be used in system operation at more than 50V DC or 240W, where general contact access is anticipated. eArche are qualified for safety under IEC 61730-2 and within this application class are considered to meet the requirements for Safety Class II.
- eArche are qualified for Application Class A(IEC 61730-1).
- Installing solar photovoltaic systems requires specialized skills and knowledge. Installation should only be performed by qualified personnel.
- Installers should assume all risks of injury that might occur during installation, including, but not limited to, the risk of electric shock.
- One single eArche may generate more than 30V DC when exposed to direct sunlight. Contact with a DC voltage of 30V or more is potentially hazardous.
- Do not disconnect during load connection.
- Photovoltaic solar eArche convert light energy to direct current electrical energy. They are designed for outdoor use. eArche can be ground mounted, mounted on rooftops, vehicles or boats. The proper design of support structures lies within the responsibility of the system designers and installers.
- Do not use mirrors or other magnifiers to concentrate sunlight onto eArche.
- When installing the system, abide to all local, regional and national statutory regulations. Obtain a building permit if necessary.
- eArche electrical characteristics are within $\pm 10\%$ of the indicated values of I_{sc} , V_{oc} and P_{max} under standard test conditions (Irradiance of $1000W/m^2$, AM 1.5 spectrum, a cell temperature of $25^{\circ}C$).
- Only use equipment, connectors, wiring and support frames suitable for solar electrical systems.
- “Always use fall protection equipment when working from heights of 6 feet (183cm) or above”. Follow Occupational Safety and Health Act (OSHA) or local governing safety regulations regarding fall protection. (UL only)

Handling safety

- Do not lift eArche by grasping eArche’ junction box or electrical leads.
- Do not stand, step or walk on any side of eArche.
- Do not drop eArche or allow objects to fall on eArche.
- Do not place any heavy objects on eArche.
- Be cautious when placing eArche down onto a surface, particularly when placing it in a corner.
- Inappropriate transport and installation may break eArche and void the warranty.
- Do not attempt to disassemble eArche, and do not remove any attached nameplates or components from eArche.

- Do not apply paint or adhesive to eArche' top surface.
- To avoid damage to the front cover and backsheet, do not scratch, “dent” or hit the front cover and backsheet.
- Do not drill holes in the ribs of SMA series. This may compromise the frame strength, cause corrosion of the ribs and void the warranty.
- Do not scratch the anodized coating of the ribs (except for grounding connection). It may cause corrosion of the ribs or compromise the ribs strength.
- A panel with broken front plate or torn back sheet cannot be repaired and must not be used since contact with any panel surface or the ribs can cause an electric shock.
- Work only under dry conditions, and use only dry tools. Do not handle panels under wet conditions unless wearing appropriate protective equipment.
- When storing uninstalled panels outdoors for any period of time, always cover the panels and ensure that the front cover faces down “on a soft flat surface” to prevent water from collecting inside the panel and causing damage to exposed connectors.

Installation safety

- Never open electrical connections or unplug connectors while the circuit is under load.
- Contact with electrically charged parts of the panels, such as terminals, can result in burns, sparks and lethal shock whether or not the panel is connected.
- Do not touch eArche unnecessarily during installation. The front surface and the ribs may be hot; there is a risk of burns and electric shock.
- Do not work in the rain, snow or in windy conditions.
- Avoid exposing cables to direct sunlight in order to prevent insulation degradation.
- Keep children well away from the system while transporting and installing mechanical and electrical components.
- Completely cover eArche with an opaque material during installation to prevent electricity from being generated.
- Do not wear metallic rings, watchbands, earrings, nose rings, lip rings or other metallic objects while installing or troubleshooting photovoltaic systems.
- Use only insulated tools that are approved for working on electrical installation.
- Follow the safety regulations for all other system components, including wires and cables, connectors, charging regulators, inverters, storage batteries, rechargeable batteries, etc.
- Under normal conditions, a photovoltaic eArche is likely to experience conditions that produce more current and/or voltage than reported at standard test conditions. Accordingly, the values of I_{sc} and V_{oc} marked on this eArche should be multiplied by a factor of 1.25 when determining component voltage

ratings, conductor current ratings, fuse sizes, and size of controls connected to the PV output.

- Only use same or connectable connectors to connect eArche to form a string, or connect to another device. Removing the connectors will void the warranty.

Fire safety

- Consult your local authority for guidelines and requirements for building or structural fire safety.
- Roof constructions and installations may affect the fire safety of a building; improper installation may create hazards in the event of a fire.
- Use components such as ground fault circuit breakers and fuses as required by local authority.
- Do not use panels near equipment or in places where flammable gases may be generated.
- eArche have been rated Fire Class C, and are suitable for mounting on to a Class A roof.

Production Identification

Each eArche has two labels providing the following information:

- Nameplate: describes the product type; rated power, rated current, rated voltage, open circuit voltage, short circuit current, all as measured under standard test conditions; weight, dimensions etc.; the maximum system voltage is 1000 volts.
- Barcode: each individual eArche has a unique serial number. The serial number has 18 digits. The 1th to 4th digits are the module type for internal use, and the 5th and the 6th digits are the year code, and the 7th and 8th digits are the month and the 9th and the 10th digits are the week code, and the 11th and the 15th digits are order number, and the 16th and the 18th digits are the sequence codes. For example, XXXX160417XXXXXXX means the module was made in the 17th week of 2016. Each module has only one bar code. It is permanently attached to the interior of eArche and is visible from the top front of eArche. This bar code is inserted prior to lamination.



Mechanical Installation

Selecting the location

- Select a suitable location for installing eArche.
- eArche should face south in northern latitudes and north in southern latitudes.
- For detailed information on the best installation angle, refer to standard solar photovoltaic installation guides or consult a reputable solar installer or systems integrator.
- eArche should not be shaded at any time. If a eArche is shaded or even partially shaded, it will fail to

perform at ideal conditions and result in lower power output.

- Do not use eArche near equipment or in locations where flammable gases may be generated or collected.

General installation

- eArche mounting structure must be made of durable, corrosion-resistant and UV-resistant material.
- Always observe the instructions and safety precautions included with eArche support frames.
- Do not drill additional mounting holes in the PV panel's ribs as this will void the warranty.
- Before installing eArche on a roof, always ensure the roof construction is suitable. In addition, any roof penetration required to mount eArche must be properly sealed to prevent leaks.
- Dust building up on the surface of eArche can impair with eArche performance. SUNMAN recommends installing eArche with a tilt angle of at least 10 degrees, making it easier for dust to be washed off by rain.
- Always keep the back sheet of the panel free from foreign objects, "plants and vegetation", or structural elements, which could come into contact with the panel, especially when the panel is under mechanical load.
- Ensure panels are not subject to wind or snow loads exceeding the maximum permissible loads, and are not subject to excessive forces due to the thermal expansion of the support structures: Refer to the following installation methods for more detailed information.

eArche product design loads

- All eArche™ product have been evaluated for test loads of 2400 Pa with the following solutions.

Mechanical Installation

Quick-bonding Installation

►For SMD Series

SMDxxxM-6X12DW, SMDxxxM-6X10DW, SMDxxxM-4X12DW, SMDxxxM-4X09DW
SMDxxxM-6X12UW, SMDxxxM-6X10UW, SMDxxxM-4X12UW, SMDxxxM-4X09UW

►Overview

- The SMD Series use quick and easy installation methods which called "Quick-bonding" is suitable for color steel roofing.

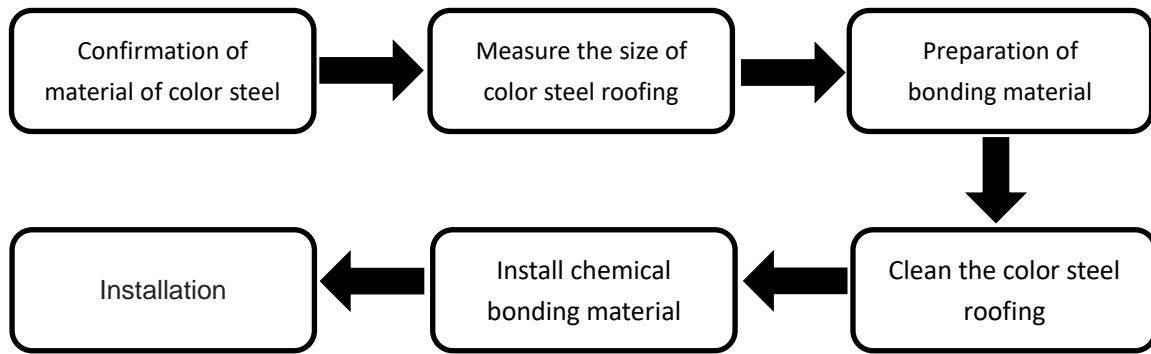

a. Confirmation of material of color steel

- SMD Series to be bonded with PE (Use of the brand: BECKER, VALSPAR, NIPPON, AKZO NOBEL) coating of zinc aluminum plate (Galvalume. AZ50, AZ55, AZ60 or Zinalume. AZ150). Substrate materials not listed in the table must be approved by the local distributors, otherwise the warranty will be invalid. Tonsan 1527 is certified to be installed on Zinalume roof profile and aluminium. Sikasil SG-20 is certified to be installed on non-matt Colorbond steel roof sheeting. Any other roof sheeting requires consultation with Sunman or its local importer.

b. Size of color steel roofing:

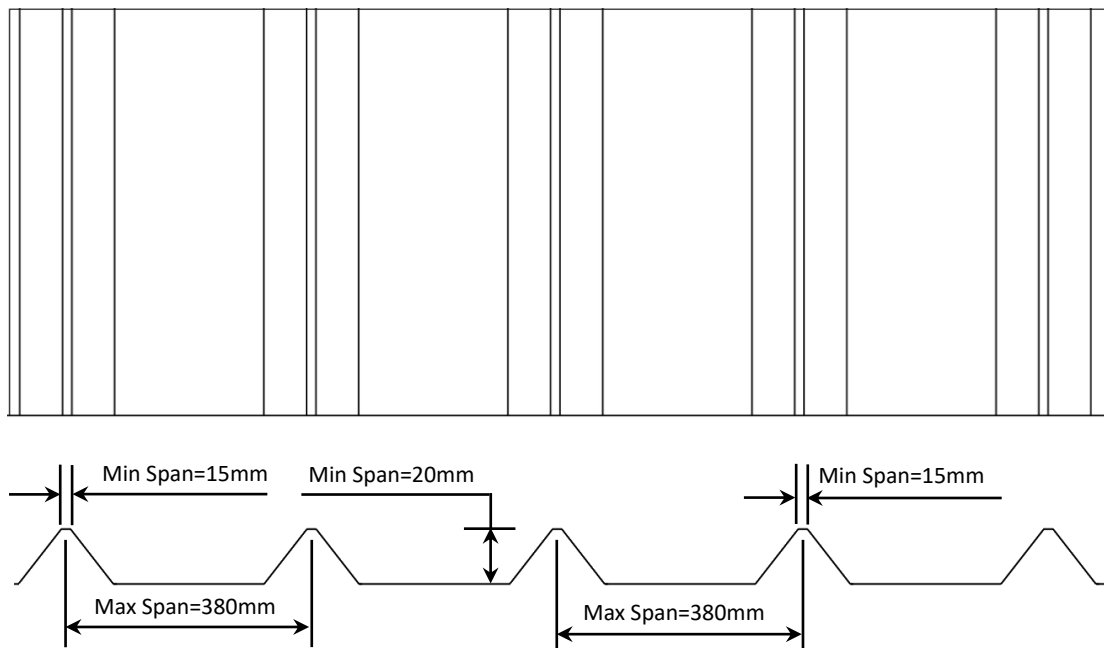

c. Preparation of bonding material

- Prepare silicone nozzle by cutting a circular opening 5-8mm wide, then cutting a V shape to one side 5-8mm long. This will ensure proper wet-out onto the substrate and a uniform adhesive thickness is achieved. Fix the nozzle onto the silicone gun.

d. Clean the color steel roofing

- Clean off excess dirt and debris off the roof sheet with rags and water. Leave to dry. If it is extremely dirty, pressure cleaning with water is recommended.

- If using Tonsan 1527, clean the roof with isopropyl alcohol and wait to dry.
- If using Sika SG-20, apply the Sika Aktivator-205 on to clean cloth. Wiping down the roof, apply to the adhesion area. Reapply until clean. Leave to dry.

e. Install chemical bonding material

- Apply the silicon with the nozzle perpendicular to the roof. The length of the chemical bonding material shall not be less than the number corresponding to L in the following table.

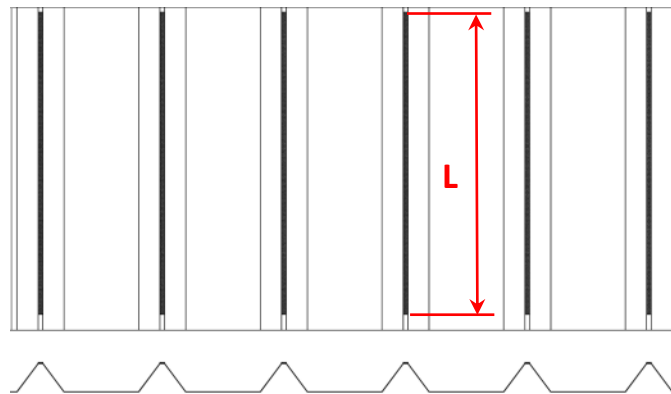

| | | |
|--------|--|---|
| eArche | SMDxxxM-4X12DW, SMDxxxM-4X12UW, SMDxxxM-4X09DW SMDxxxM-4X09UW | SMDxxxM-6X12DW, SMDxxxM-6X12UW, SMDxxxM-6X10DW, SMDxxxM-6X10UW |
| L | 665mm | 995mm |

- Please see below for proper bead application

| | |
|--|----------------|
| | |
| ✔ Correct dimension ($h \approx 5 \text{ mm}$) | ❌ Too flat |
| | |
| ❌ Too high, too small | ❌ Poor wetting |

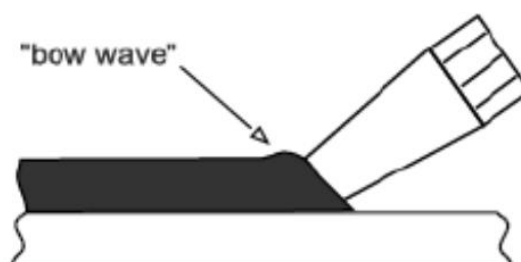

f. Layout of SMD Series

- Layout (For SMD Series: SMDxxxM-6X12DW, SMDxxxM-6X12UW, SMDxxxM-6X10DW, SMDxxxM-6X10UW)

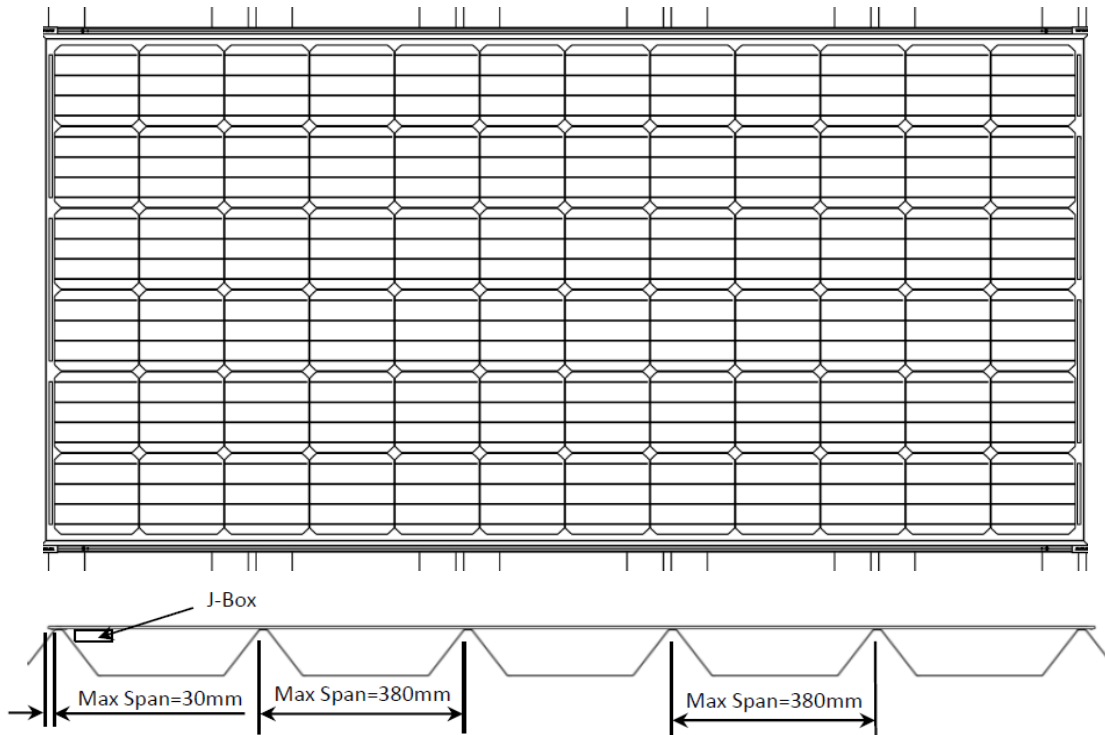

- Layout (For SMD Series: SMDxxxM-4X12DW, SMDxxxM-4X12UW, SMDxxxM-4X09DW, SMDxxxM-4X09UW)

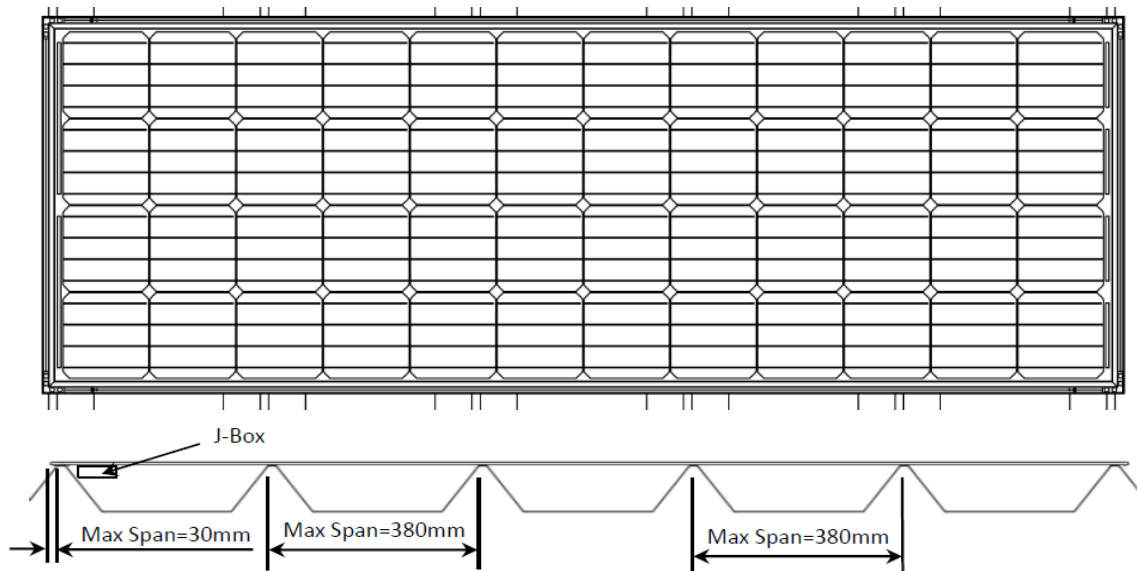

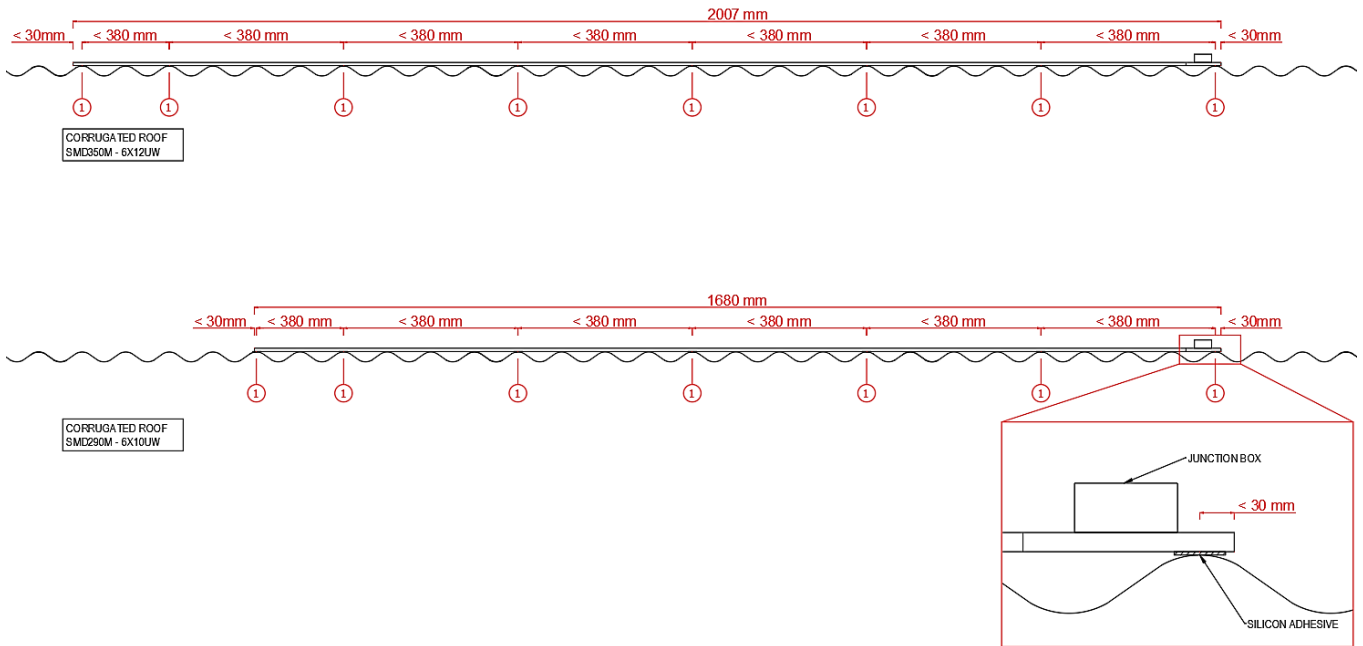

►Note:

- Please refer to appendix regarding Kliplok 406-like and Kliplok 700-like roof sheeting mounting.
- Please contact the local distributors if you are not sure whether your color steel roofing is suit for SMD Series or you have any question about this installation method.
- Please contact the local distributors if you want to remove SMD Series from your color steel roofing.
- Do not install using quick bonding method when rain is present
- Do not install using quick bonding method when wind speeds greater than 10m/s are present at the site within 24 hours
- Roof and ambient temperature during installation shall be between -15°C and 45°C
- If installation method is strictly adhered to, Sunman will provide a 10 year warranty for the Tonsan 1527

Framed Installation

►For SMA Series

SMAxxxM-6X12DW, SMAxxxM-6X10DW, SMAxxxM-4X12DW, SMAxxxM-4X09DW
 SMAxxxM-6X12UW, SMAxxxM-6X10UW, SMAxxxM-4X12UW, SMAxxxM-4X09UW

- Clamps can be used for the connection of SMA series components and support system. The installation must be completed according to the following example, otherwise the warranty will be invalid.
- Horizontal installation of SMA series components.
- SMA series components must be properly secured to their supports so that they can withstand the pressure of the load, including the rise and pressure of the wind. It is the responsibility of the installer to ensure that the mounting fixture used ensures that the assembly is strong enough.

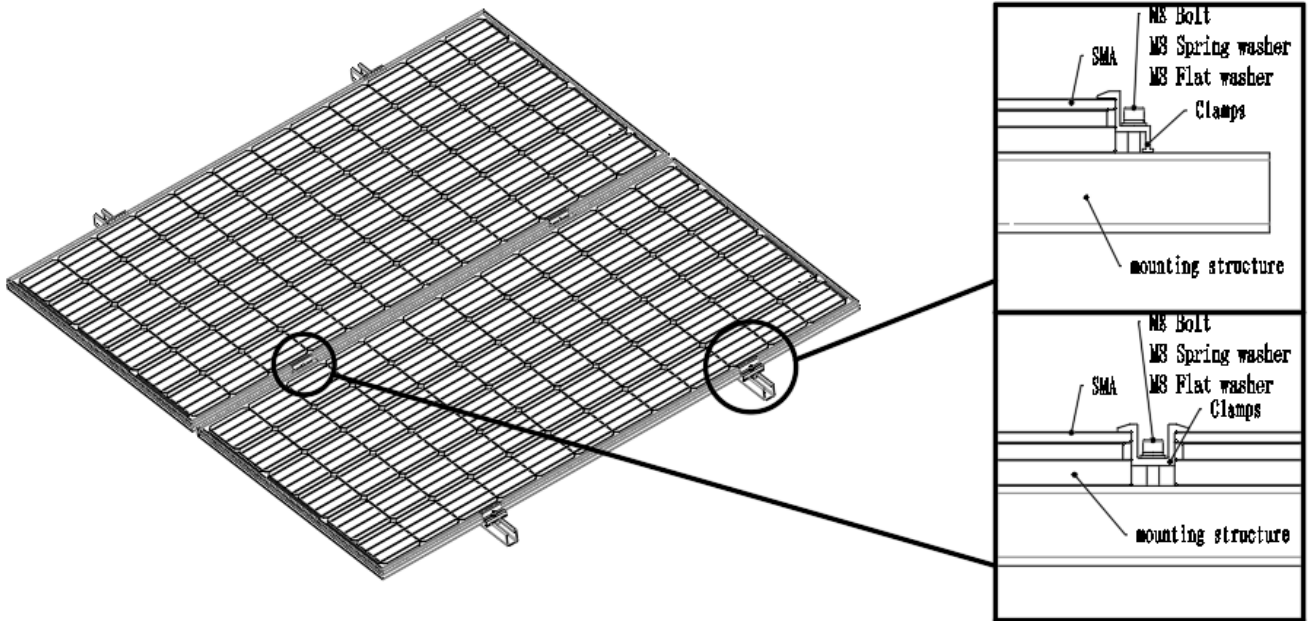

- Layout(For SMA Series: SMAxxxM-6X12DW, SMAxxxM-6X10DW, SMAxxxM-4X12DW, SMAxxxM-4X09DW, SMAxxxM-6X12UW, SMAxxxM-6X10UW, SMAxxxM-4X12UW, SMAxxxM-4X09UW)

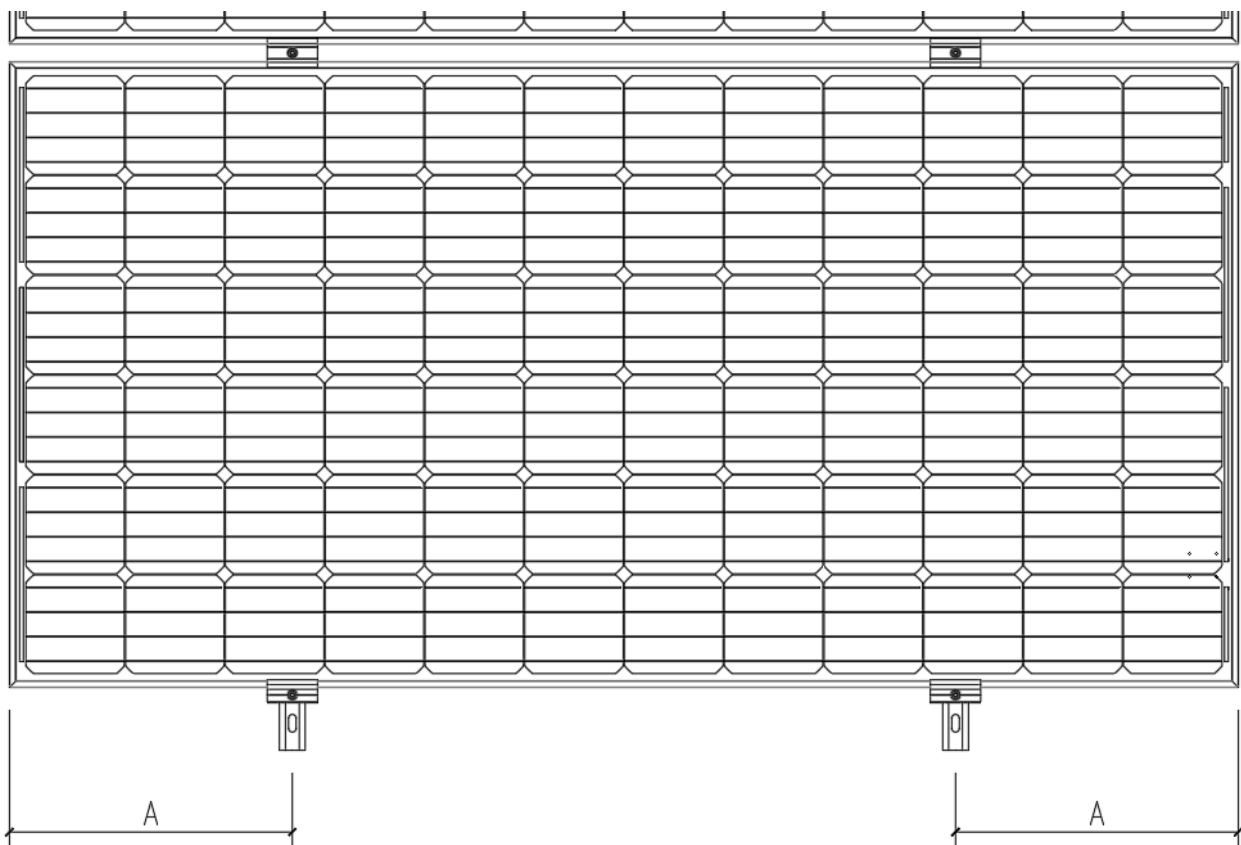

| Specifications | $A_{MAX}(mm)$ | $A_{MIN}(mm)$ |
|----------------|---------------|---------------|
| SMAxxxM-6X12DW | 450 | 250 |
| SMAxxxM-6X10DW | 400 | 210 |
| SMAxxxM-4X12DW | 450 | 250 |

| | | |
|----------------|-----|-----|
| SMAxxxM-4X09DW | 350 | 200 |
| SMAxxxM-6X12UW | 450 | 250 |
| SMAxxxM-6X10UW | 400 | 210 |
| SMAxxxM-4X12UW | 450 | 250 |
| SMAxxxM-4X09UW | 350 | 200 |

Grounding

- For grounding and bonding requirements, please refer to regional and national safety and electricity standards. If grounding is required, use a recommended connector type for the grounding wire.
- For grounding, this guide refers to module frame grounding. If grounding is required, make sure module frames (metal exposed to touch) are always grounded.
- SUNMAN recommends always refer to local state and national code requirements for PV module grounding. SUNMAN highly recommends negative grounding if it's allowed by local authorities.
- When attaching the frame grounding hardware and wire to the frame it must be placed corresponding to the ground symbol stamped location to ensure proper electrical connection.
- For grounding should be performed by a qualified electrician.

For SMD Series

Grounding layouts

- Earthing of the array is a requirement as per AS5033 Australian Standards. In order to provide a conductivity path between the panel frames, an earth lug has been provided on the frame of the panel. The most efficient way to earth the panel and maintain continuity is to pull through the earth cable through the ducting and fix earth cable at each lug. This branch of earth cable can then be connect to the main return earth cable going back to a common ground.

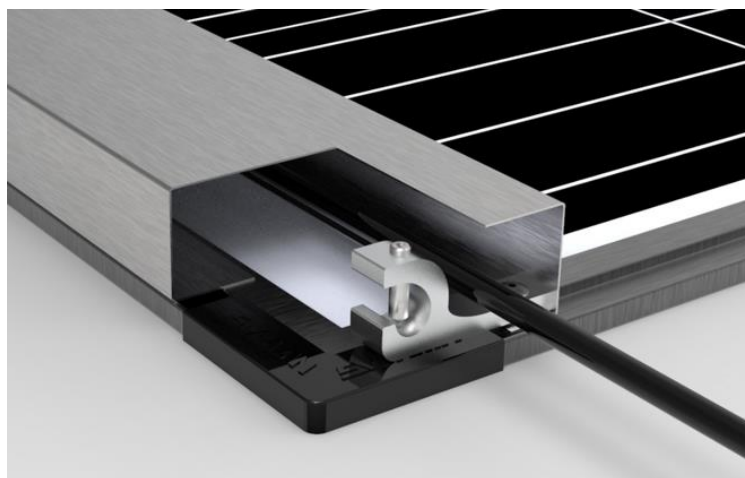

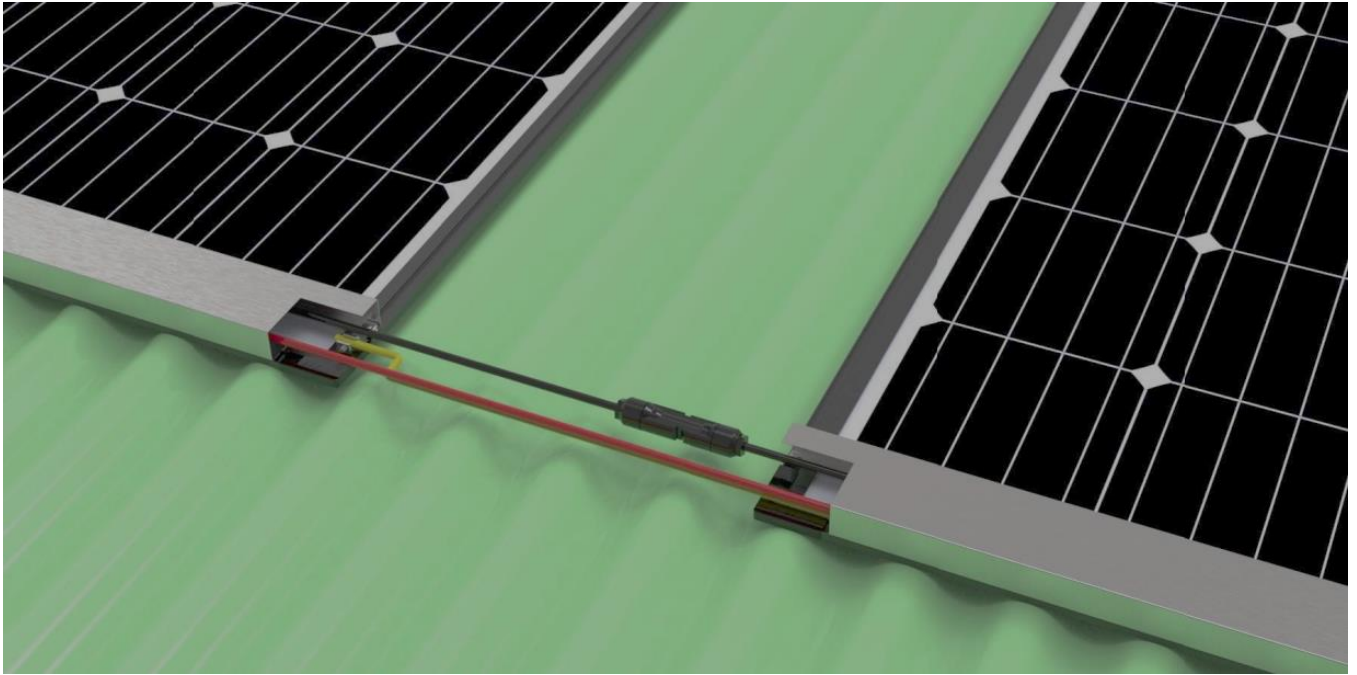

For SMA Series

- All modules frame and mounting must be earthed as per the installer's National Standard.
- Proper grounding is achieved by bonding all conductors on the module frame and metal mounting structures continuously with a suitable grounding conductor.
- Third party grounding solutions are acceptable. These solutions must comply with local standards and all associated manufacturer instructions.

Electrical installation

- Any hardware used must be compatible with the mounting structure material to avoid galvanic corrosion.
- It is not recommended to use eArche with different configurations in the same system.
- Excessive cables must be organized or fixed in an adequate way, e.g. attached to the mounting structure by using non-metallic cable ties.
- For applications requiring high operating voltage several eArche can be connected in series to form a string of eArche; the system voltage is then equal to the sum of the voltage of each eArche.
- For applications requiring high operating currents several strings of eArche can be connected in parallel; the system current is then equal to the sum of the current of each string of eArche.
- The maximum system voltage is 1000 volts DC.
- The maximum number of series connected eArche depends on system design, the type of inverter used and environmental conditions.

- Please make sure no more than two strings in parallel if eArche without any fuse or blocking diode to be connected according to the maximum series fuse rating of eArche and local electrical installation code.
- There is no limitation on the number of eArche that can be connected in parallel (fuse for each string should be considered), the number of eArche is determined by system design parameters such as current or power output.
- To prevent the cables and the connectors from overheating, the cross section of the cables and the capacity of the connectors must be selected to suit the maximum system short circuit current. The recommended cable is PV wire (temperature rating is 90°C) with a cross section of at least 2.5mm².
- Please refer to local regulations to determine the system wires size, type and temperature.
- eArche are supplied with connectors to be used for system electrical connections. Please refer to the local regulations and the datasheets for which connectors are allowed to be used.
- To ensure reliable electric connection and to prevent possible intrusion of humidity, connectors must be mated and locked together until a click can be heard.
- Long-term exposure to wet environments may cause connectors' poor connectivity, resulting in current leakage and poor conductivity. SUNMAN recommend proper connector/cable/wire management to prevent moisture intrusion. Depending on the amount of humidity, SUNMAN recommends periodic inspections of the installation system to maintain optimal eArche' performance.
- The DC current generated by photovoltaic systems can be converted into AC and fed into a public Grid. As local utilities' policies on connecting renewable energy systems to the Grids vary from region to region. Always seek the advice from a qualified system designer or integrator. Building permits, inspections and approvals by the local utility are to be expected.

Disclaimer of liability

- As the adherence to this manual and the conditions or methods of installation, operation, use and maintenance of photovoltaic (PV) products are beyond SUNMAN's control, SUNMAN does not accept responsibility and expressly disclaims liability for any loss, damage, or expense arising out of or in any way connected with such installation, operation, use or maintenance.
- No responsibility is assumed by SUNMAN for any infringement of patents or other rights of third parties, which may result from the use of the PV product. No license is granted by implication or otherwise under any patent or patent rights.
- The information in this manual is based on SUNMAN's best knowledge and experience and is believed to be reliable; But such information including product specification (without limitations) and suggestions do not constitute a warranty, express or implied. SUNMAN reserves the right to change the manual, eArche, the specifications, or product information sheets without prior notice.

Products Data

| Series | Products | STC | | | | | Dimensions | Weight | Fuse Rating | Max.series quantity |
|----------------|----------------|-----|------|------|------|------|-------------------------|--------|-------------|---------------------|
| | | Pmp | Vmp | Imp | Voc | Isc | | | | |
| SMDxxxM-6X12DW | SMD355M-6X12DW | 355 | 39.5 | 8.99 | 48.1 | 9.51 | 1979mm X 1019mm X 5.6mm | 6.5kg | 20A | 16 |
| | SMD350M-6X12DW | 350 | 39.2 | 8.93 | 47.9 | 9.46 | 1979mm X 1019mm X 5.6mm | 6.5kg | | |
| | SMD345M-6X12DW | 345 | 38.9 | 8.87 | 47.7 | 9.41 | 1979mm X 1019mm X 5.6mm | 6.5kg | | |
| | SMD340M-6X12DW | 340 | 38.6 | 8.81 | 47.5 | 9.36 | 1979mm X 1019mm X 5.6mm | 6.5kg | | |
| | SMD335M-6X12DW | 335 | 38.3 | 8.75 | 47.3 | 9.31 | 1979mm X 1019mm X 5.6mm | 6.5kg | | |
| | SMD330M-6X12DW | 330 | 38.0 | 8.69 | 47.1 | 9.22 | 1979mm X 1019mm X 5.6mm | 6.5kg | | |
| | SMD325M-6X12DW | 325 | 37.7 | 8.63 | 46.9 | 9.13 | 1979mm X 1019mm X 5.6mm | 6.5kg | | |
| SMDxxxM-6X10DW | SMD295M-6X10DW | 295 | 32.8 | 9.00 | 40.1 | 9.52 | 1662mm X 1019mm X 5.6mm | 5.5kg | 20A | 20 |
| | SMD290M-6X10DW | 290 | 32.6 | 8.90 | 39.9 | 9.43 | 1662mm X 1019mm X 5.6mm | 5.5kg | | |
| | SMD285M-6X10DW | 285 | 32.4 | 8.80 | 39.7 | 9.34 | 1662mm X 1019mm X 5.6mm | 5.5kg | | |
| | SMD280M-6X10DW | 280 | 32.2 | 8.70 | 39.5 | 9.25 | 1662mm X 1019mm X 5.6mm | 5.5kg | | |
| | SMD275M-6X10DW | 275 | 32.0 | 8.60 | 39.3 | 9.16 | 1662mm X 1019mm X 5.6mm | 5.5kg | | |
| | SMD270M-6X10DW | 270 | 31.8 | 8.50 | 39.1 | 9.07 | 1662mm X 1019mm X 5.6mm | 5.5kg | | |
| SMDxxxM-4X12DW | SMD235M-4X12DW | 235 | 26.1 | 9.01 | 31.7 | 9.54 | 1979mm X 689mm X 5.6mm | 4.6kg | 20A | 25 |
| | SMD230M-4X12DW | 230 | 25.8 | 8.92 | 31.5 | 9.45 | 1979mm X 689mm X 5.6mm | 4.6kg | | |
| | SMD225M-4X12DW | 225 | 25.5 | 8.83 | 31.3 | 9.36 | 1979mm X 689mm X 5.6mm | 4.6kg | | |
| | SMD220M-4X12DW | 220 | 25.2 | 8.74 | 31.1 | 9.27 | 1979mm X 689mm X 5.6mm | 4.6kg | | |
| | SMD215M-4X12DW | 215 | 24.9 | 8.64 | 30.9 | 9.18 | 1979mm X 689mm X 5.6mm | 4.6kg | | |
| SMDxxxM-4X09DW | SMD175M-4X09DW | 175 | 19.5 | 8.98 | 23.9 | 9.50 | 1503mm X 689mm X 5.6mm | 3.7kg | 20A | 33 |
| | SMD170M-4X09DW | 170 | 19.2 | 8.86 | 23.7 | 9.39 | 1503mm X 689mm X 5.6mm | 3.7kg | | |
| | SMD165M-4X09DW | 165 | 18.9 | 8.74 | 23.5 | 9.28 | 1503mm X 689mm X 5.6mm | 3.7kg | | |
| | SMD160M-4X09DW | 160 | 18.6 | 8.61 | 23.2 | 9.17 | 1503mm X 689mm X 5.6mm | 3.7kg | | |
| SMDxxxM-6X12UW | SMD355M-6X12UW | 355 | 39.5 | 8.99 | 48.1 | 9.51 | 2007mm X 1019mm X 5.6mm | 6.6kg | 20A | 16 |
| | SMD350M-6X12UW | 350 | 39.2 | 8.93 | 47.9 | 9.46 | 2007mm X 1019mm X 5.6mm | 6.6kg | | |
| | SMD345M-6X12UW | 345 | 38.9 | 8.87 | 47.7 | 9.41 | 2007mm X 1019mm X 5.6mm | 6.6kg | | |
| | SMD340M-6X12UW | 340 | 38.6 | 8.81 | 47.5 | 9.36 | 2007mm X 1019mm X 5.6mm | 6.6kg | | |
| | SMD335M-6X12UW | 335 | 38.3 | 8.75 | 47.3 | 9.31 | 2007mm X 1019mm X 5.6mm | 6.6kg | | |
| | SMD330M-6X12UW | 330 | 38.0 | 8.69 | 47.1 | 9.22 | 2007mm X 1019mm X 5.6mm | 6.6kg | | |
| | SMD325M-6X12UW | 325 | 37.7 | 8.63 | 46.9 | 9.13 | 2007mm X 1019mm X 5.6mm | 6.6kg | | |
| SMDxxxM-6X10UW | SMD295M-6X10UW | 295 | 32.8 | 9.00 | 40.1 | 9.52 | 1690mm X 1019mm X 5.6mm | 5.6kg | 20A | 20 |
| | SMD290M-6X10UW | 290 | 32.6 | 8.90 | 39.9 | 9.43 | 1690mm X 1019mm X 5.6mm | 5.6kg | | |
| | SMD285M-6X10UW | 285 | 32.4 | 8.80 | 39.7 | 9.34 | 1690mm X 1019mm X 5.6mm | 5.6kg | | |
| | SMD280M-6X10UW | 280 | 32.2 | 8.70 | 39.5 | 9.25 | 1690mm X 1019mm X 5.6mm | 5.6kg | | |
| | SMD275M-6X10UW | 275 | 32.0 | 8.60 | 39.3 | 9.16 | 1690mm X 1019mm X 5.6mm | 5.6kg | | |
| | SMD270M-6X10UW | 270 | 31.8 | 8.50 | 39.1 | 9.07 | 1690mm X 1019mm X 5.6mm | 5.6kg | | |
| SMDxxxM-4X12UW | SMD235M-4X12UW | 235 | 26.1 | 9.01 | 31.7 | 9.54 | 2007mm X 689mm X 5.6mm | 4.7kg | 20A | 25 |
| | SMD230M-4X12UW | 230 | 25.8 | 8.92 | 31.5 | 9.45 | 2007mm X 689mm X 5.6mm | 4.7kg | | |
| | SMD225M-4X12UW | 225 | 25.5 | 8.83 | 31.3 | 9.36 | 2007mm X 689mm X 5.6mm | 4.7kg | | |
| | SMD220M-4X12UW | 220 | 25.2 | 8.74 | 31.1 | 9.27 | 2007mm X 689mm X 5.6mm | 4.7kg | | |
| | SMD215M-4X12UW | 215 | 24.9 | 8.64 | 30.9 | 9.18 | 2007mm X 689mm X 5.6mm | 4.7kg | | |
| SMDxxxM-4X09UW | SMD175M-4X09UW | 175 | 19.5 | 8.98 | 23.9 | 9.50 | 1531mm X 689mm X 5.6mm | 3.8kg | 20A | 33 |
| | SMD170M-4X09UW | 170 | 19.2 | 8.86 | 23.7 | 9.39 | 1531mm X 689mm X 5.6mm | 3.8kg | | |
| | SMD165M-4X09UW | 165 | 18.9 | 8.74 | 23.5 | 9.28 | 1531mm X 689mm X 5.6mm | 3.8kg | | |

| | | | | | | | | | | |
|----------------|----------------|-----|------|------|------|------|------------------------|-------|-----|----|
| | SMD160M-4X09UW | 160 | 18.6 | 8.61 | 23.2 | 9.17 | 1531mm X 689mm X 5.6mm | 3.8kg | | |
| SMAxxxM-6X12DW | SMA355M-6X12DW | 355 | 39.5 | 8.99 | 48.1 | 9.51 | 1955mm X 995mm X 35mm | 8.9kg | 20A | 16 |
| | SMA350M-6X12DW | 350 | 39.2 | 8.93 | 47.9 | 9.46 | 1955mm X 995mm X 35mm | 8.9kg | | |
| | SMA345M-6X12DW | 345 | 38.9 | 8.87 | 47.7 | 9.41 | 1955mm X 995mm X 35mm | 8.9kg | | |
| | SMA340M-6X12DW | 340 | 38.6 | 8.81 | 47.5 | 9.36 | 1955mm X 995mm X 35mm | 8.9kg | | |
| | SMA335M-6X12DW | 335 | 38.3 | 8.75 | 47.3 | 9.31 | 1955mm X 995mm X 35mm | 8.9kg | | |
| | SMA330M-6X12DW | 330 | 38.0 | 8.69 | 47.1 | 9.22 | 1955mm X 995mm X 35mm | 8.9kg | | |
| SMAxxxM-6X10DW | SMA295M-6X10DW | 295 | 32.8 | 9.00 | 40.1 | 9.52 | 1638mm X 995mm X 35mm | 7.6kg | 20A | 20 |
| | SMA290M-6X10DW | 290 | 32.6 | 8.90 | 39.9 | 9.43 | 1638mm X 995mm X 35mm | 7.6kg | | |
| | SMA285M-6X10DW | 285 | 32.4 | 8.80 | 39.7 | 9.34 | 1638mm X 995mm X 35mm | 7.6kg | | |
| | SMA280M-6X10DW | 280 | 32.2 | 8.70 | 39.5 | 9.25 | 1638mm X 995mm X 35mm | 7.6kg | | |
| | SMA275M-6X10DW | 275 | 32.0 | 8.60 | 39.3 | 9.16 | 1638mm X 995mm X 35mm | 7.6kg | | |
| | SMA270M-6X10DW | 270 | 31.8 | 8.50 | 39.1 | 9.07 | 1638mm X 995mm X 35mm | 7.6kg | | |
| SMAxxxM-4X12DW | SMA235M-4X12DW | 235 | 26.1 | 9.01 | 31.7 | 9.54 | 1955mm X 665mm X 35mm | 6.3kg | 20A | 25 |
| | SMA230M-4X12DW | 230 | 25.8 | 8.92 | 31.5 | 9.45 | 1955mm X 665mm X 35mm | 6.3kg | | |
| | SMA225M-4X12DW | 225 | 25.5 | 8.83 | 31.3 | 9.36 | 1955mm X 665mm X 35mm | 6.3kg | | |
| | SMA220M-4X12DW | 220 | 25.2 | 8.74 | 31.1 | 9.27 | 1955mm X 665mm X 35mm | 6.3kg | | |
| | SMA215M-4X12DW | 215 | 24.9 | 8.64 | 30.9 | 9.18 | 1955mm X 665mm X 35mm | 6.3kg | | |
| SMAxxxM-4X09DW | SMA175M-4X09DW | 175 | 19.5 | 8.98 | 23.9 | 9.50 | 1479mm X 665mm X 35mm | 5.0kg | 20A | 33 |
| | SMA170M-4X09DW | 170 | 19.2 | 8.86 | 23.7 | 9.39 | 1479mm X 665mm X 35mm | 5.0kg | | |
| | SMA165M-4X09DW | 165 | 18.9 | 8.74 | 23.5 | 9.28 | 1479mm X 665mm X 35mm | 5.0kg | | |
| | SMA160M-4X09DW | 160 | 18.6 | 8.61 | 23.2 | 9.17 | 1479mm X 665mm X 35mm | 5.0kg | | |
| SMAxxxM-6X12UW | SMA355M-6X12UW | 355 | 39.5 | 8.99 | 48.1 | 9.51 | 1983mm X 995mm X 35mm | 9.0kg | 20A | 16 |
| | SMA350M-6X12UW | 350 | 39.2 | 8.93 | 47.9 | 9.46 | 1983mm X 995mm X 35mm | 9.0kg | | |
| | SMA345M-6X12UW | 345 | 38.9 | 8.87 | 47.7 | 9.41 | 1983mm X 995mm X 35mm | 9.0kg | | |
| | SMA340M-6X12UW | 340 | 38.6 | 8.81 | 47.5 | 9.36 | 1983mm X 995mm X 35mm | 9.0kg | | |
| | SMA335M-6X12UW | 335 | 38.3 | 8.75 | 47.3 | 9.31 | 1983mm X 995mm X 35mm | 9.0kg | | |
| | SMA330M-6X12UW | 330 | 38.0 | 8.69 | 47.1 | 9.22 | 1983mm X 995mm X 35mm | 9.0kg | | |
| | SMA325M-6X12UW | 325 | 37.7 | 8.63 | 46.9 | 9.13 | 1983mm X 995mm X 35mm | 9.0kg | | |
| SMAxxxM-6X10UW | SMA295M-6X10UW | 295 | 32.8 | 9.00 | 40.1 | 9.52 | 1666mm X 995mm X 35mm | 7.7kg | 20A | 20 |
| | SMA290M-6X10UW | 290 | 32.6 | 8.90 | 39.9 | 9.43 | 1666mm X 995mm X 35mm | 7.7kg | | |
| | SMA285M-6X10UW | 285 | 32.4 | 8.80 | 39.7 | 9.34 | 1666mm X 995mm X 35mm | 7.7kg | | |
| | SMA280M-6X10UW | 280 | 32.2 | 8.70 | 39.5 | 9.25 | 1666mm X 995mm X 35mm | 7.7kg | | |
| | SMA275M-6X10UW | 275 | 32.0 | 8.60 | 39.3 | 9.16 | 1666mm X 995mm X 35mm | 7.7kg | | |
| | SMA270M-6X10UW | 270 | 31.8 | 8.50 | 39.1 | 9.07 | 1666mm X 995mm X 35mm | 7.7kg | | |
| SMAxxxM-4X12UW | SMA235M-4X12UW | 235 | 26.1 | 9.01 | 31.7 | 9.54 | 1983mm X 665mm X 35mm | 6.4kg | 20A | 25 |
| | SMA230M-4X12UW | 230 | 25.8 | 8.92 | 31.5 | 9.45 | 1983mm X 665mm X 35mm | 6.4kg | | |
| | SMA225M-4X12UW | 225 | 25.5 | 8.83 | 31.3 | 9.36 | 1983mm X 665mm X 35mm | 6.4kg | | |
| | SMA220M-4X12UW | 220 | 25.2 | 8.74 | 31.1 | 9.27 | 1983mm X 665mm X 35mm | 6.4kg | | |
| | SMA215M-4X12UW | 215 | 24.9 | 8.64 | 30.9 | 9.18 | 1983mm X 665mm X 35mm | 6.4kg | | |
| SMAxxxM-4X09UW | SMA175M-4X09UW | 175 | 19.5 | 8.98 | 23.9 | 9.50 | 1507mm X 665mm X 35mm | 5.1kg | 20A | 33 |
| | SMA170M-4X09UW | 170 | 19.2 | 8.86 | 23.7 | 9.39 | 1507mm X 665mm X 35mm | 5.1kg | | |
| | SMA165M-4X09UW | 165 | 18.9 | 8.74 | 23.5 | 9.28 | 1507mm X 665mm X 35mm | 5.1kg | | |
| | SMA160M-4X09UW | 160 | 18.6 | 8.61 | 23.2 | 9.17 | 1507mm X 665mm X 35mm | 5.1kg | | |